

ECN	REV	DESCRIPTION	DATE	APPROVED

PCB LAYOUT & PANEL HOLE SIZE

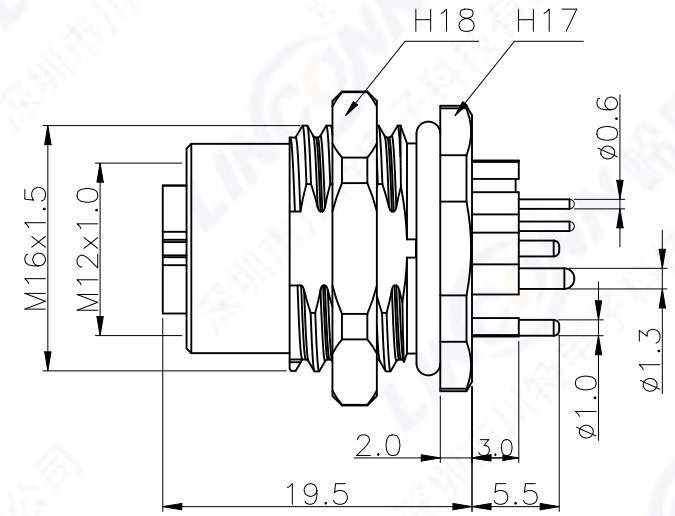
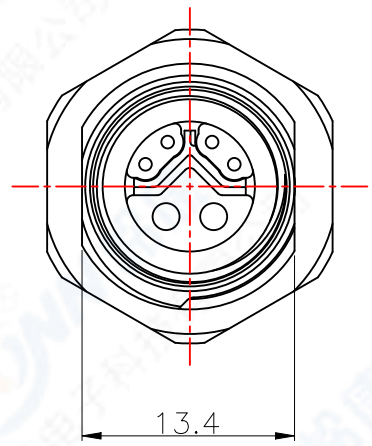
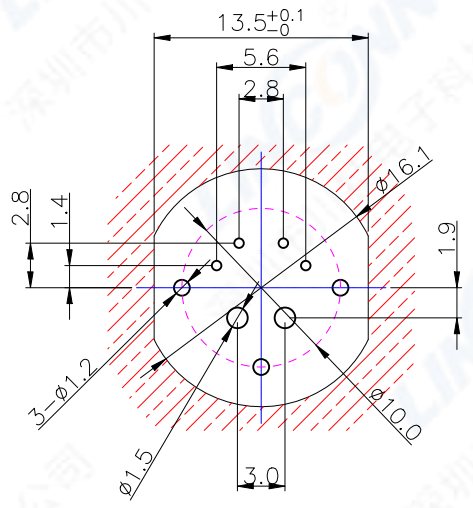

技术特性/Technical Characteristics

1. 寿命/Durability: >500 mate/unmate cycles
2. Pin接触电阻/ Pin Contact Resistance: ≤10 mΩ
3. 绝缘电阻/Insulation Resistance: ≥ 100 MΩ
4. 额定电压/Rated voltage a.c. or d.c.: 50V
5. 额定电流(电源针)/Rated current(power contacts): 12A
6. 温度等级/Rated Temperature: -25° C, +80° C
7. 盐雾/Corrosion Resistance: Salt spray test, >48h

5	六角螺母/Hexagonal nut: 黄铜镀镍/Brass, Nickel plated
4	密封圈/O-RING: Rubber
3	外壳/Outer Shell: 黄铜镀镍/Brass, Nickel plated
2	绝缘体/Insulator: PA BLACK
1	母针芯/PIN: 磷铜镀金/Phosphor copper, G/F
序号 ITEM	名称 & 规格/Name & Description

	SCALE
	F
SHEET	DIMENSION
1 OF 1	MM
DWG NO.	REV.
M12F	A0

TOLERANCES ARE:	
DECIMALES	ANGLES
x ± 1	±
.x + 0.5	
APPROVALS	DATE
APPROVED:	
CHECKED:	
CHECKED:	
DRAWN: pengsen	02/04/2023

TITLE: M12 6Pin female socket	
PART NO. M12YF8306FNBG1	REV. *
Linconn Elc Tech Co.,LTD	