







1. 芯数/NO. of contacts

系列/Series	303	304	305	306	308
孔位排列/Pin Number					
适配线缆/Conductor size	24AWG	24AWG	24AWG	26AWG	26AWG
导体直径/Pin size	1.0mm	1.0mm	1.0mm	0.7mm	0.6mm
额定电流/Rated current	3A	3A	3A	1A	1A
额定电压/Rated voltage	60V	30V	30V	30V	30V

2. 绝缘体型号/Insulator Coded

Coded	A	B
型号		

3. 面板开孔/RECOMMENDED PANEL CUT-OUT

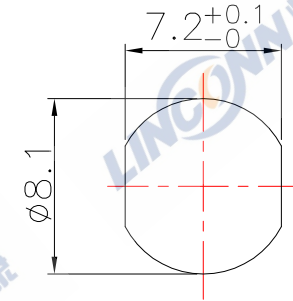

4. 编码原则/Part Number

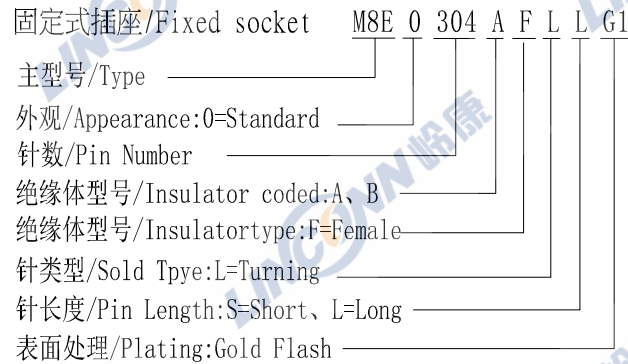

5. 技术特性/Technical Characteristics

1. 寿命/Durability: >1000 mate/unmate cycles
2. 针接触电阻/ Pin Contact Resistance: ≤10 mΩ
3. 绝缘电阻/Insulation Resistance: ≥ 100 MΩ
4. 温度等级/Rated Temperature: -25°C,+80°C
5. 盐雾/Corrosion Resistance: Salt spray test,>48h
6. 防水等级/Waterproof: IP67

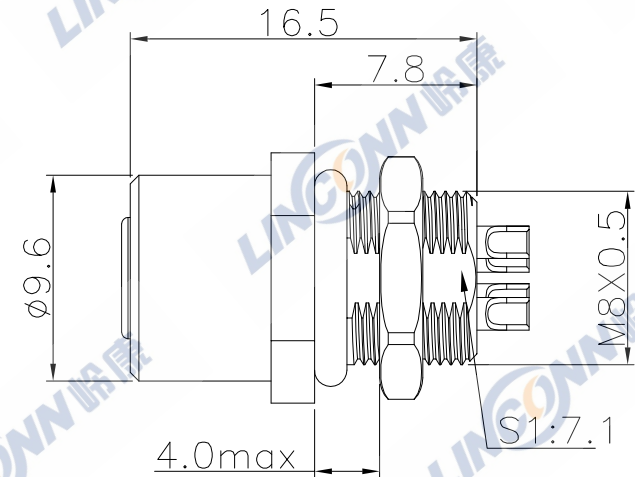
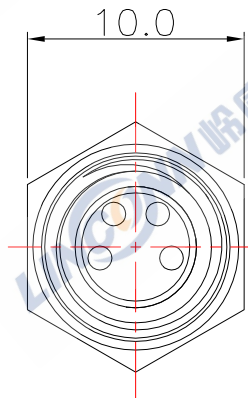

5	六角螺母/Hexagonal nut: 黄铜镀镍/Brass, Nickel plated
4	母针芯/PIN: 磷铜镀金/Phosphor copper, G/F
3	外壳/Outer Shell: 黄铜镀镍/Brass, Nickel plated
2	密封圈/O-RING: Rubber
1	绝缘体/Insulator: PA BLACK
序号ITEM	名称 & 规格/Name & Description

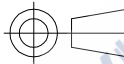
	SCALE	TOLERANCES ARE: DECIMALES ANGLES · X± 0.2 · XX± 0.1	APPROVALS	DATE
	F			
SHEET	DIMENSION	APPROVED:		
1 OF 1	MM	CHECKED:		
DWG NO.	REV.	DRAWN: S.peng 03/24/2014		
M8E	A0			

TITLE: 固定式插座/Fixed socket	
PART NO. M8E0304AFLG1	REV. *
 Linconn Etc Tech Co.,LTD	